

1.03 1

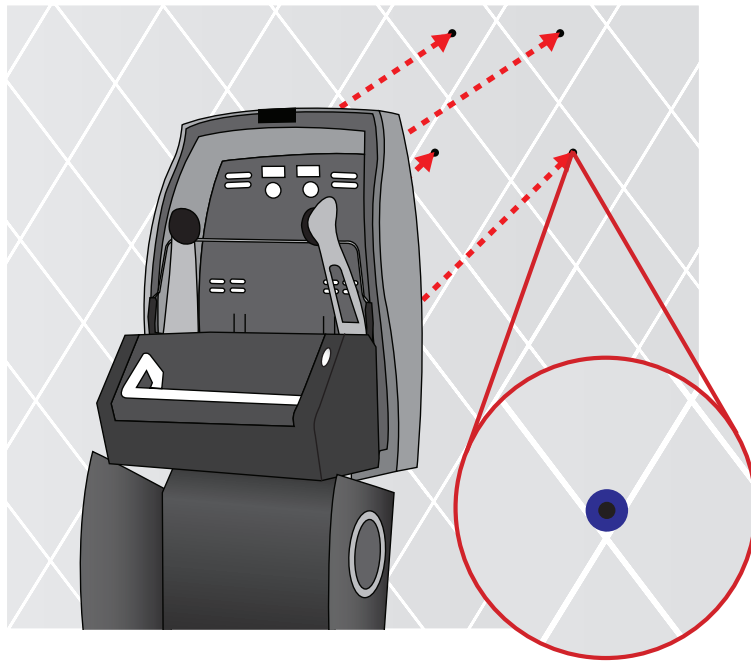

1.04 1

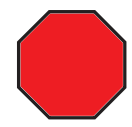
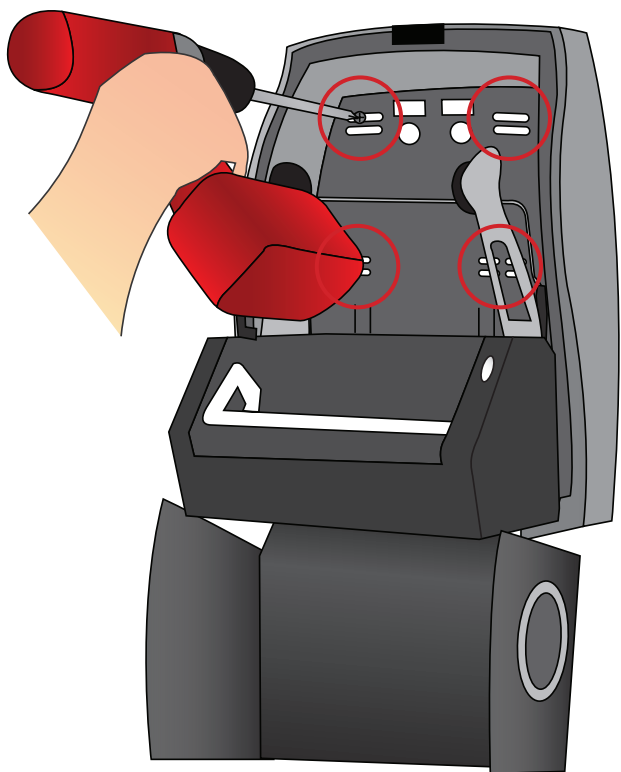

2.01

2

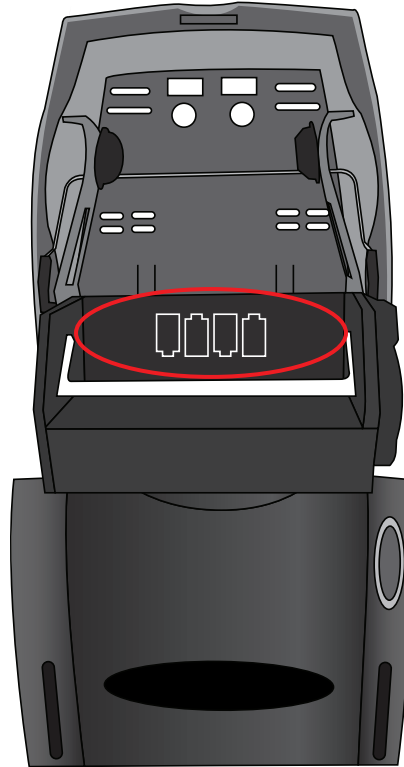

2.02

2

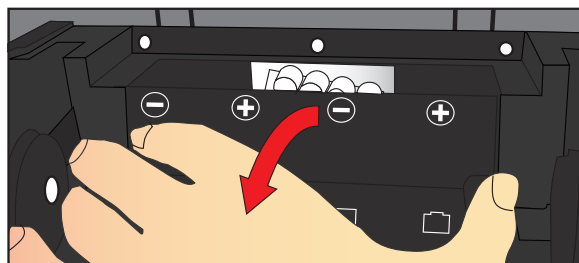
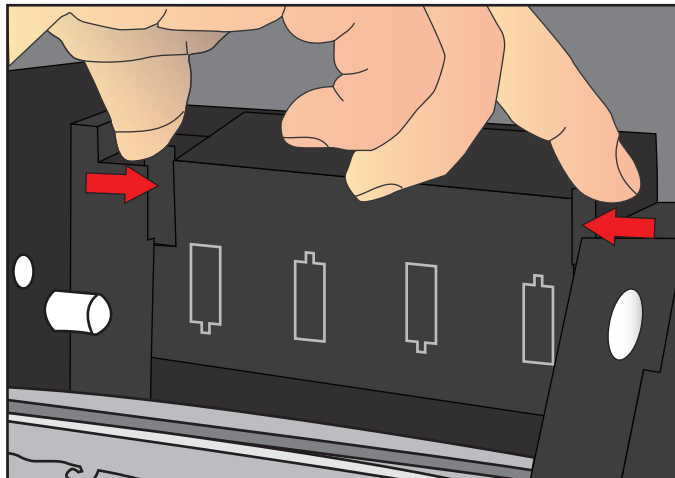

2.03

2

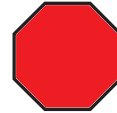
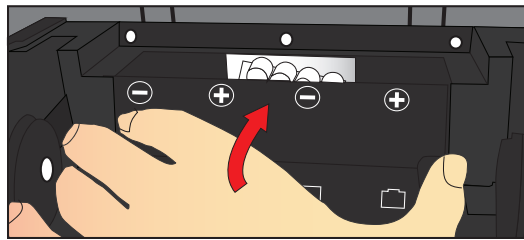
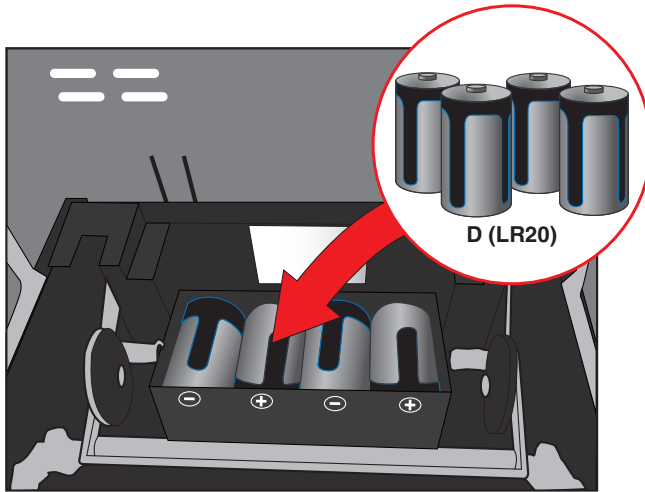

3.01

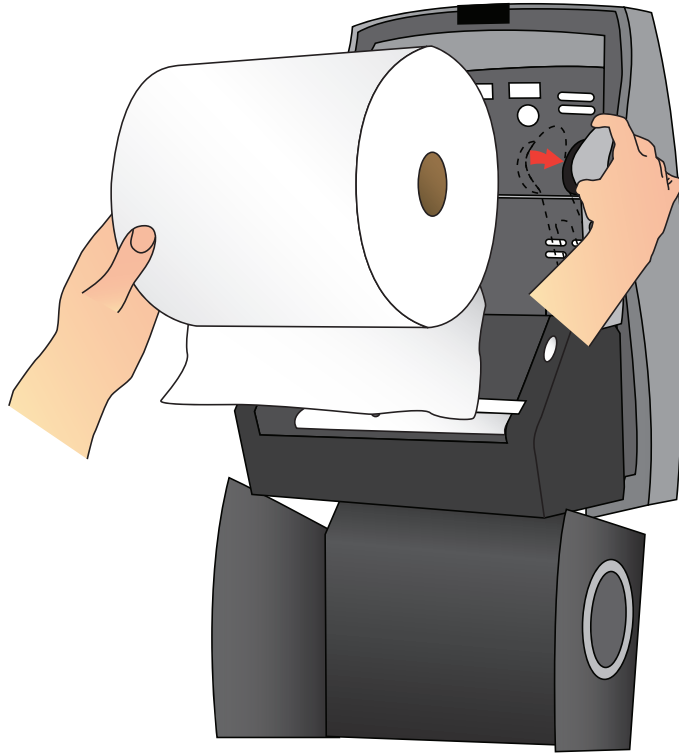

3

3.02

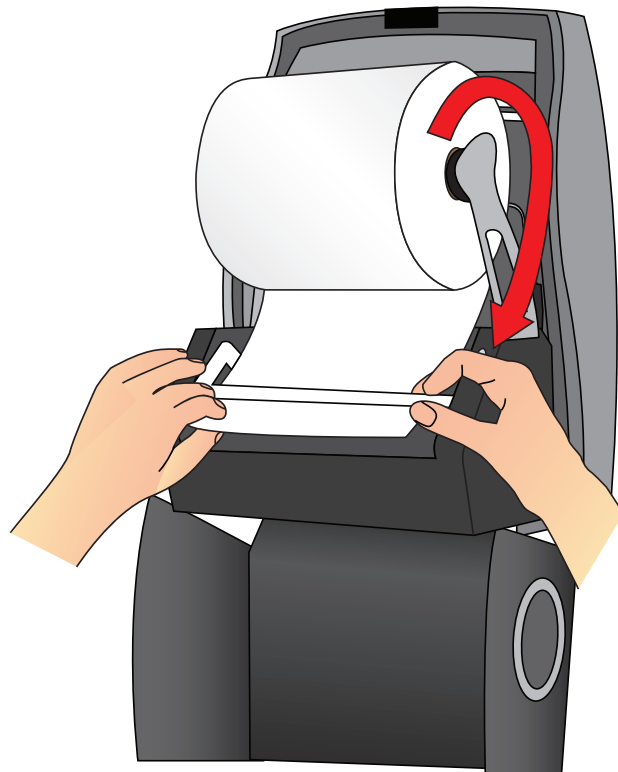

3

3.03

3

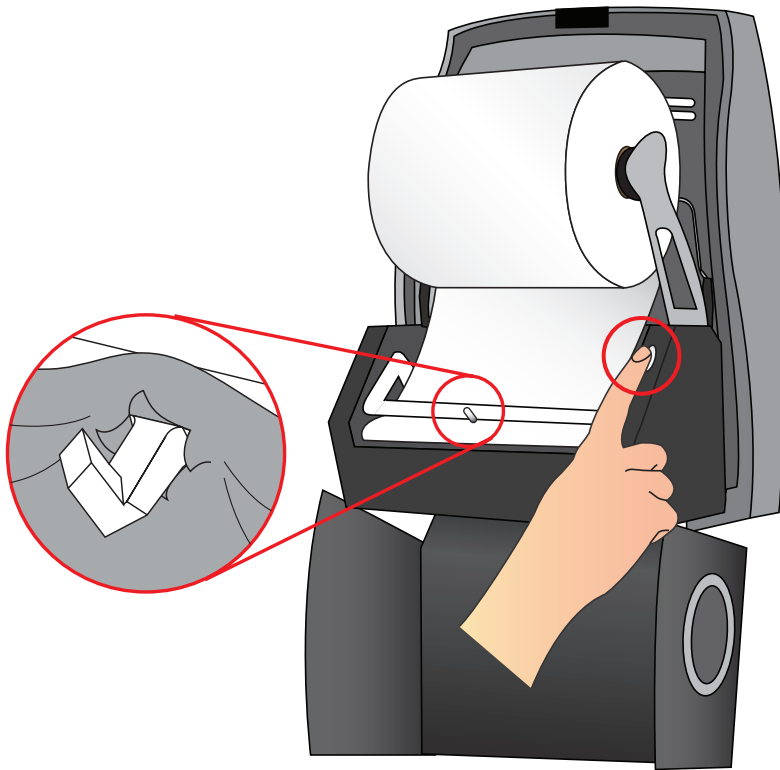

3.04

3

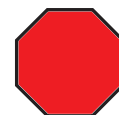
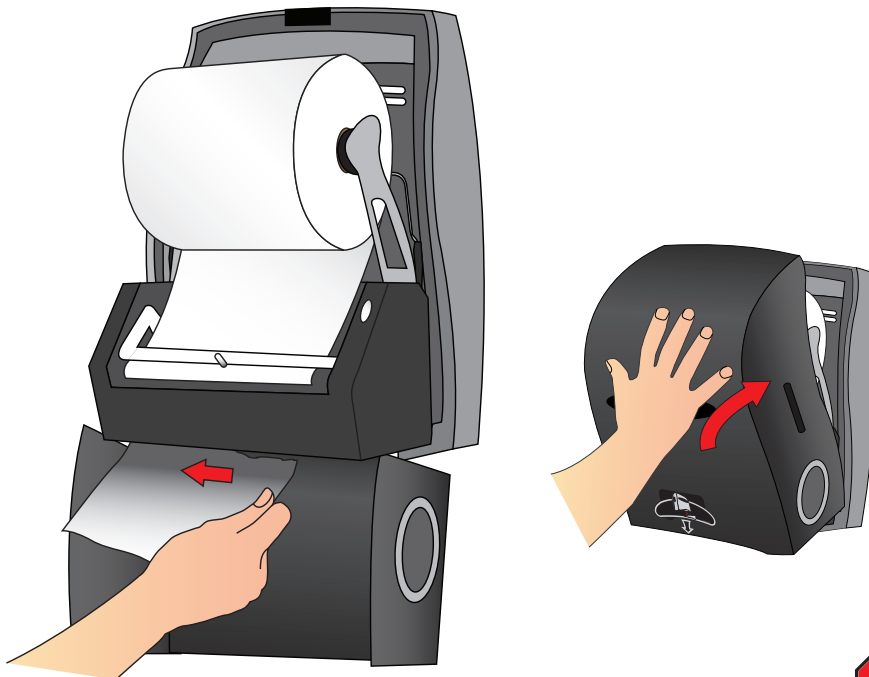

4.01



4

4.02

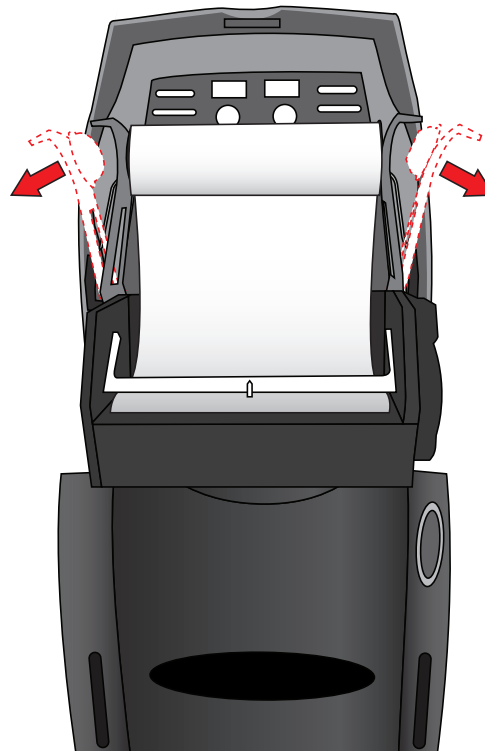

4

4.03

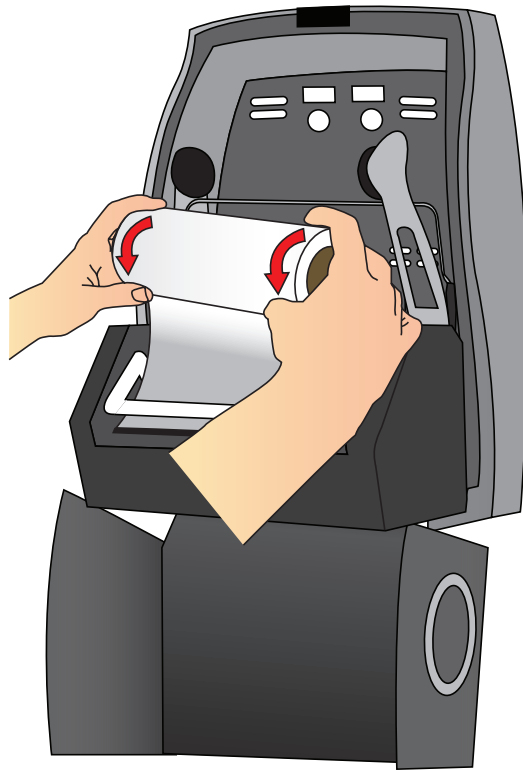

4

4.04

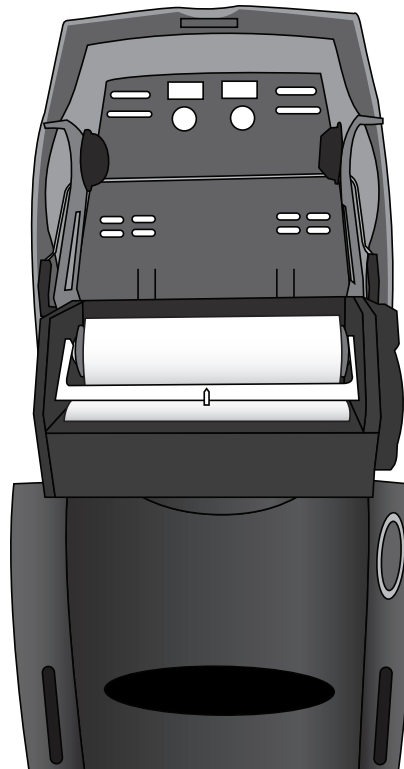

4



4.05

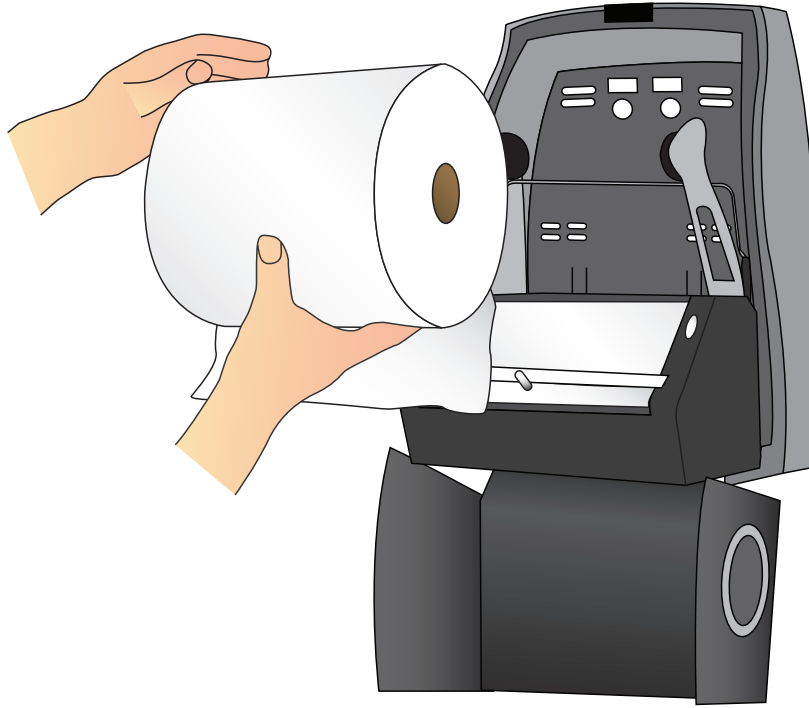

4

4.06

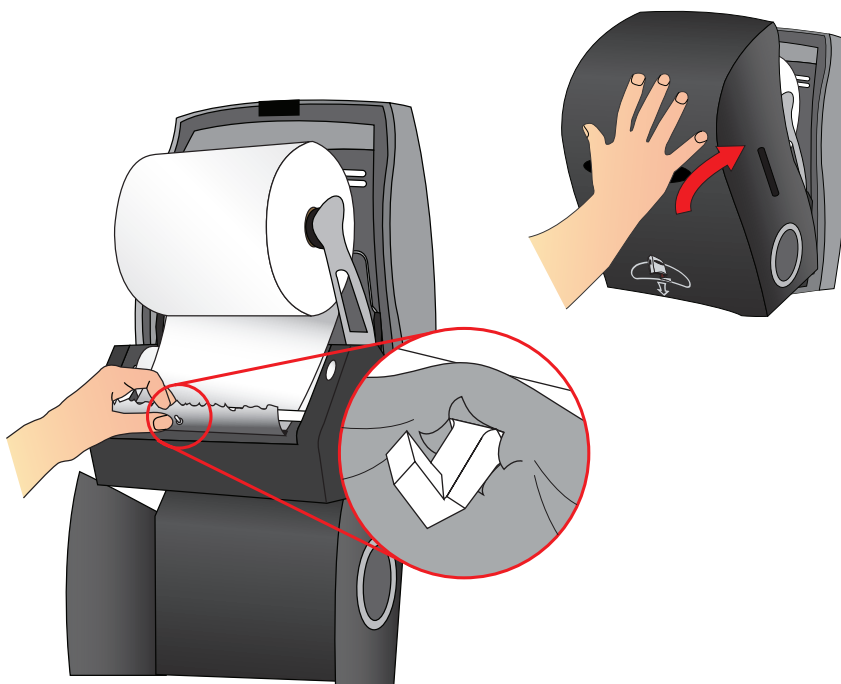

4

5.01



5

5.02

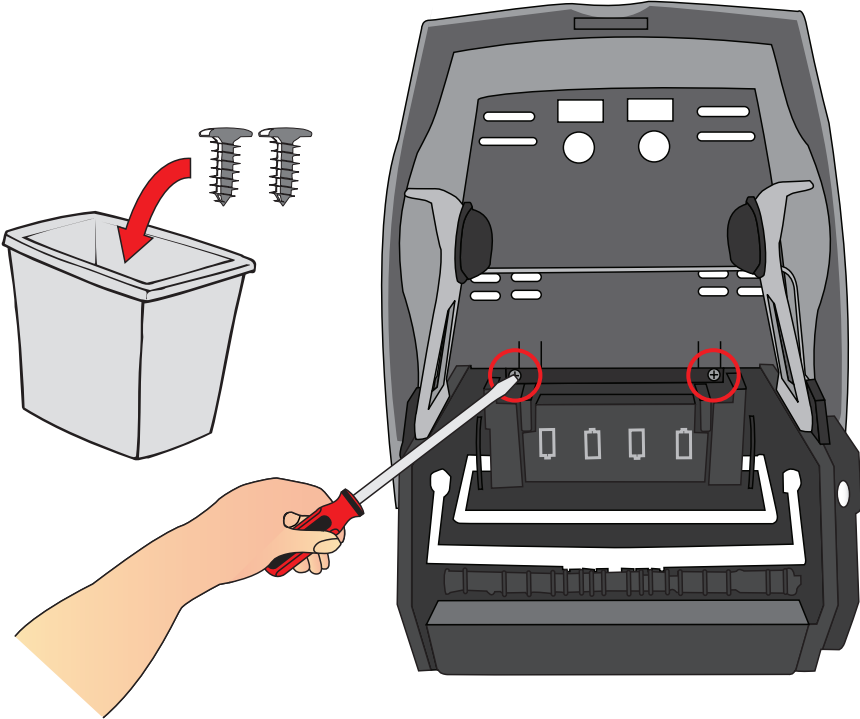

5

5.03

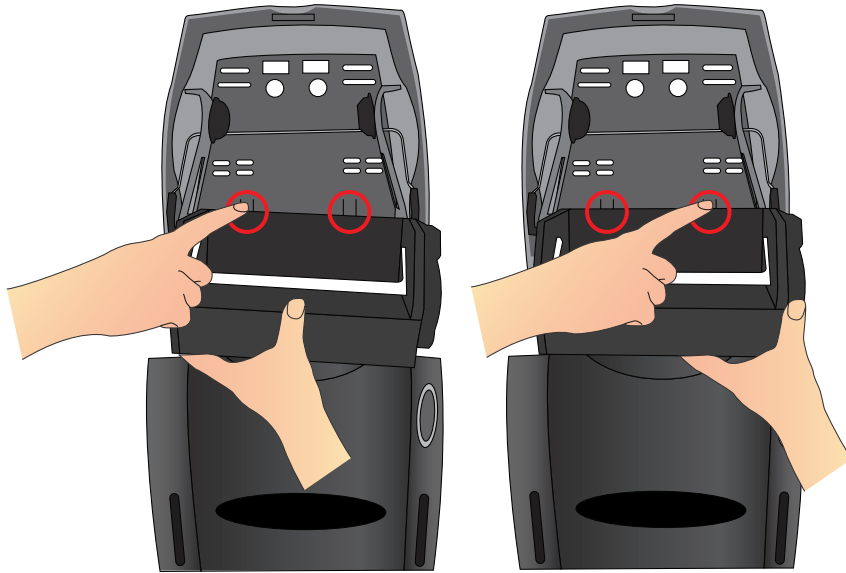

5

5.04

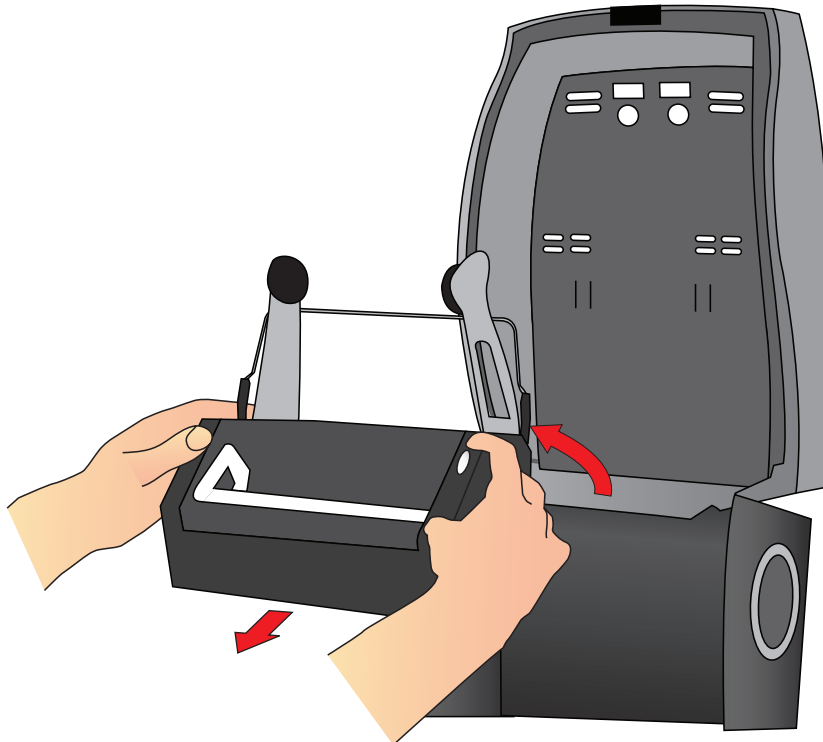

5

5.05

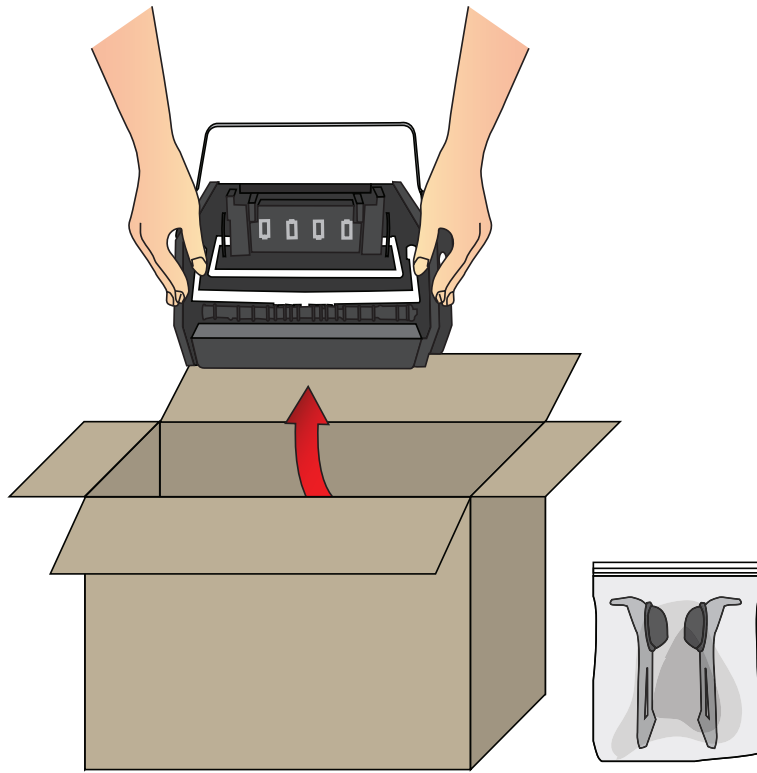

5

5.06

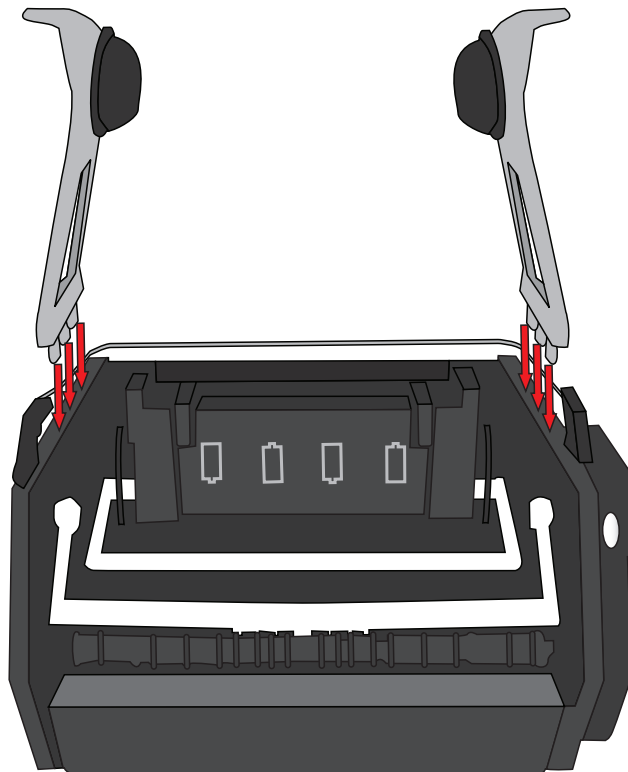

5

5.07

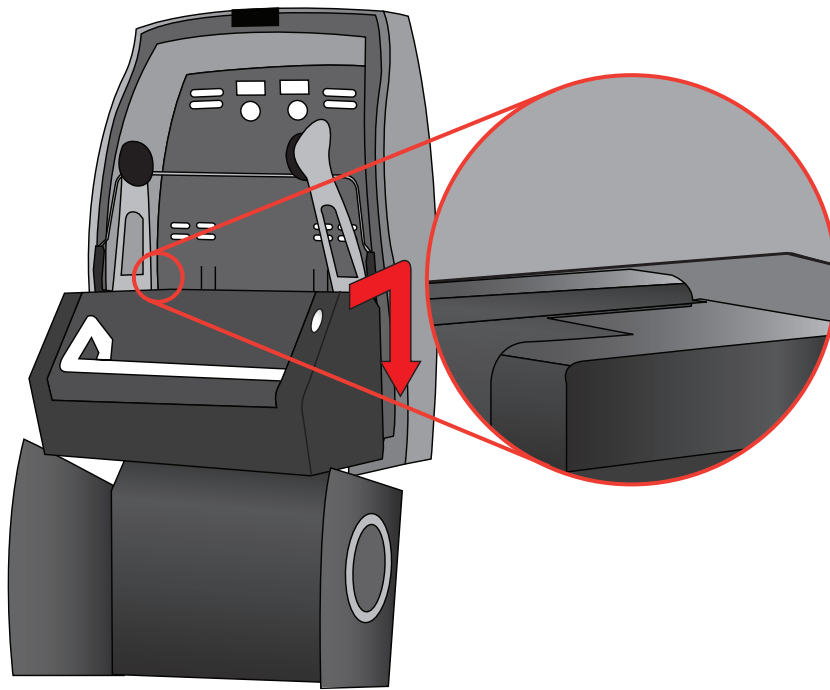

5

5.08

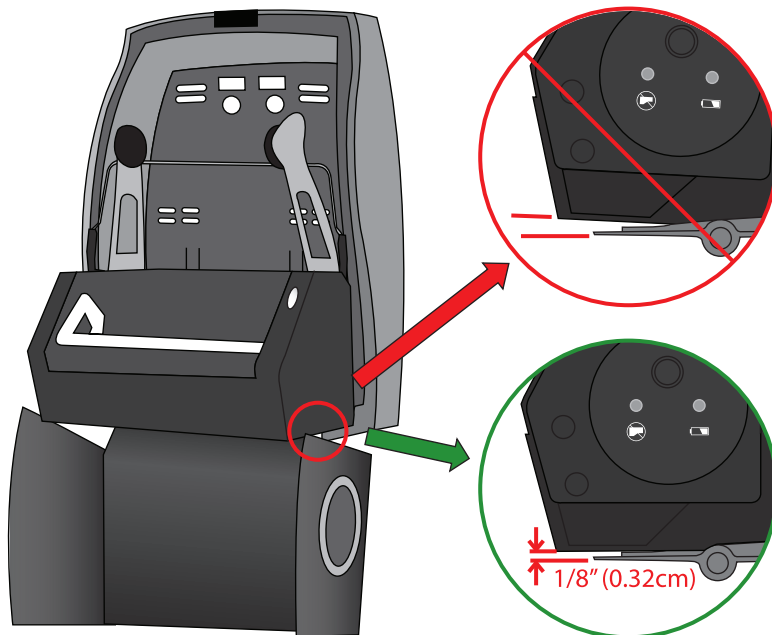

5

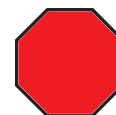

6.01



6

6.02

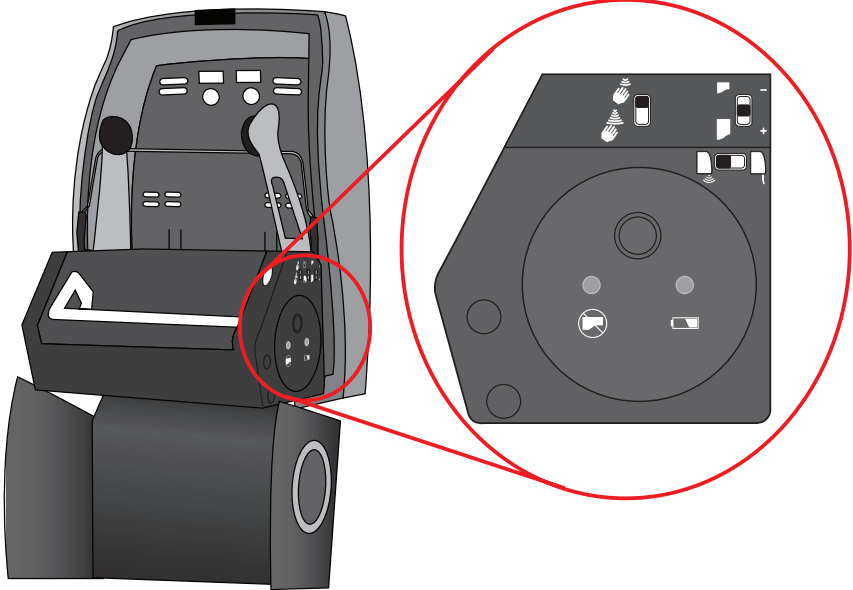

6

6.03

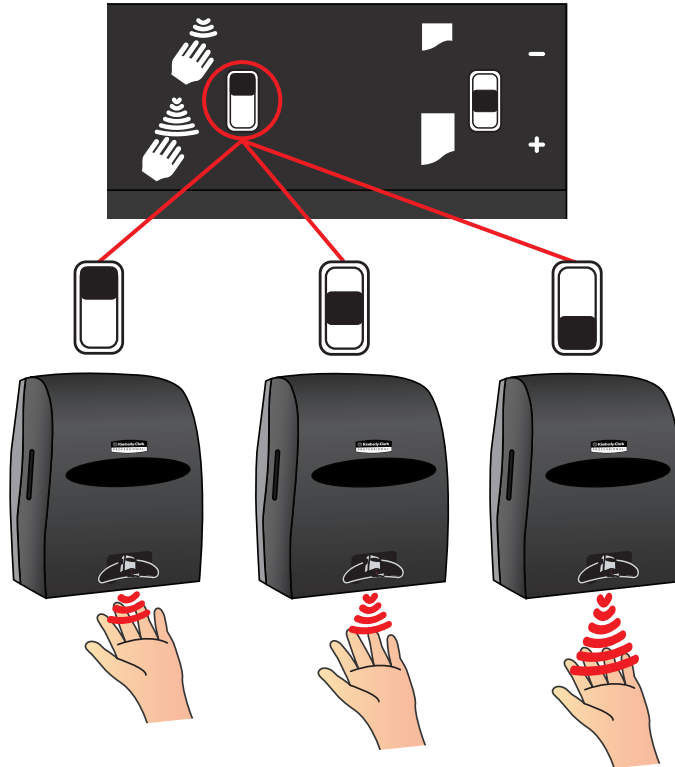

6

6.04

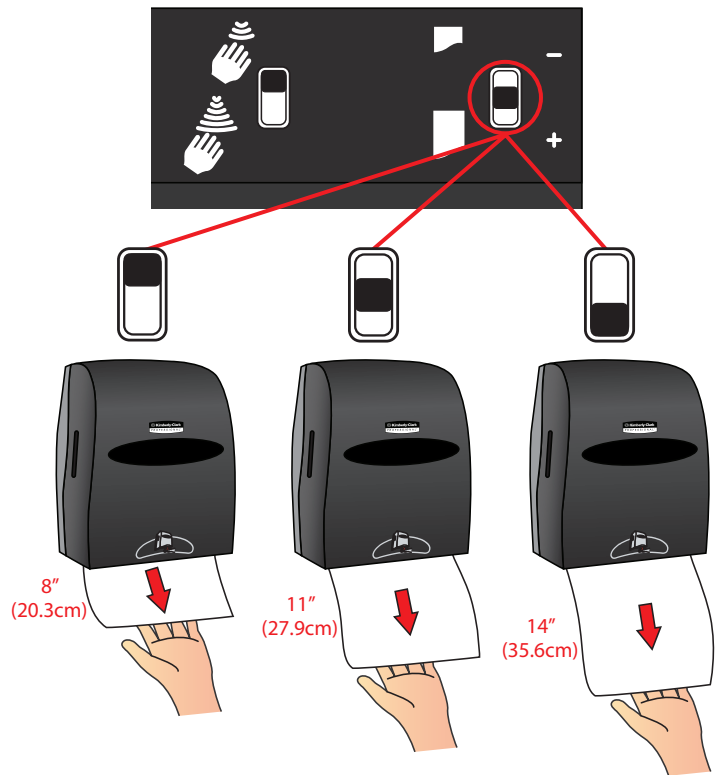

6

6.05

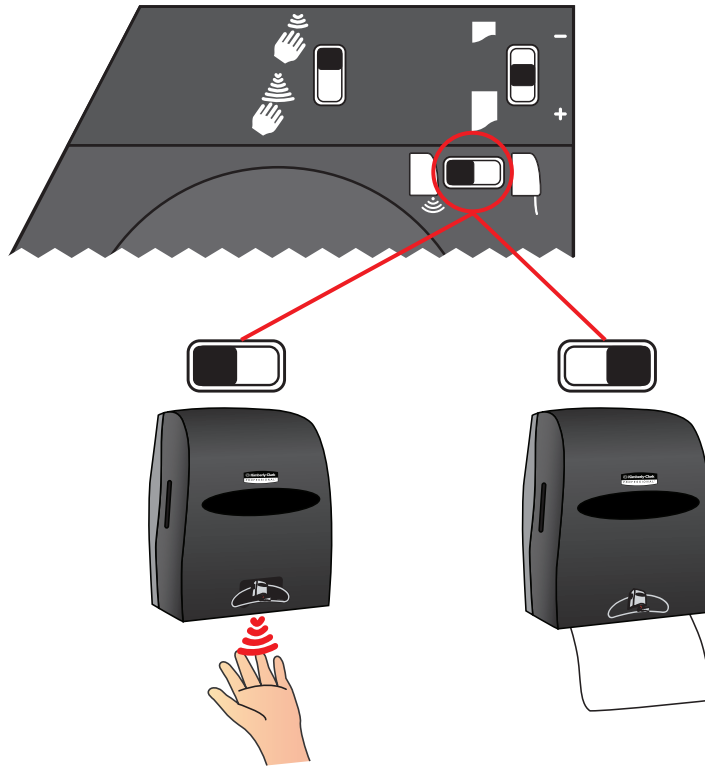

6

6.06

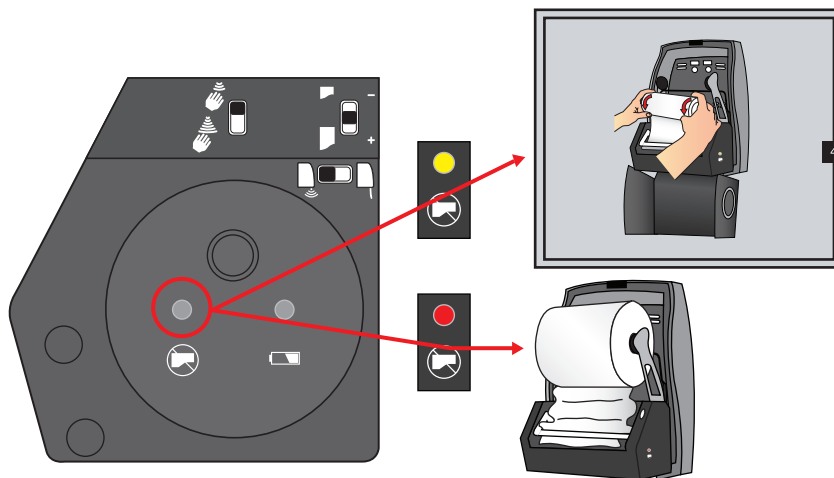

6



6.07

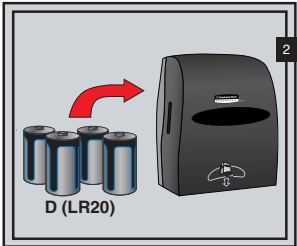
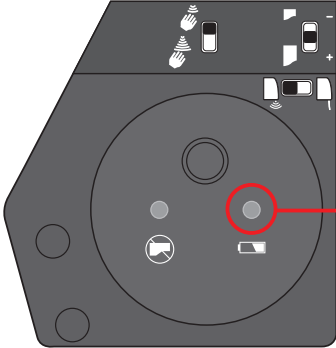

6

7.01



7

7.02

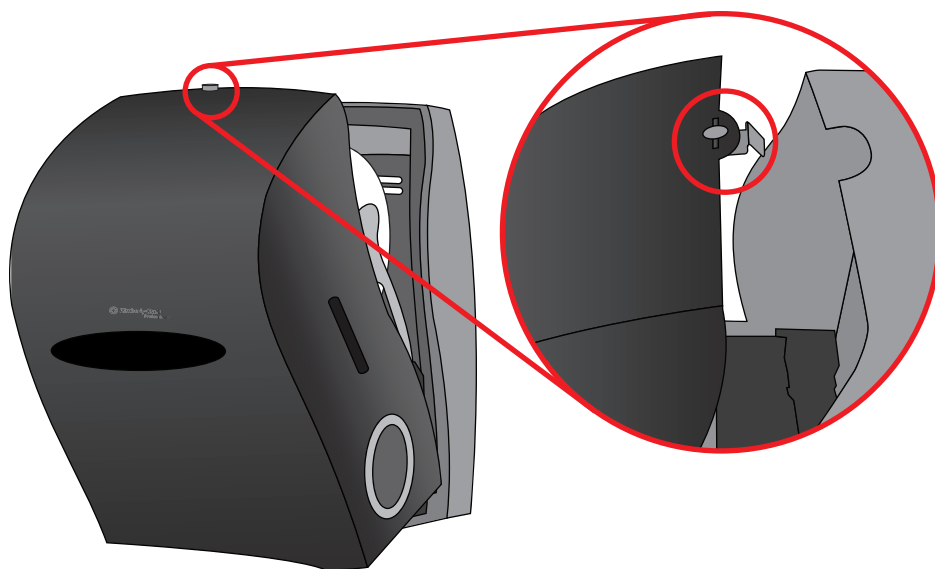

7

7.03

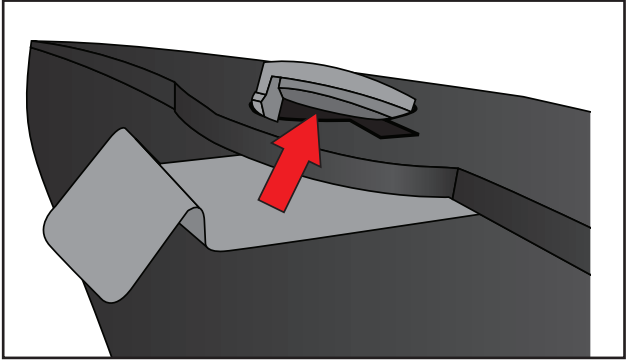
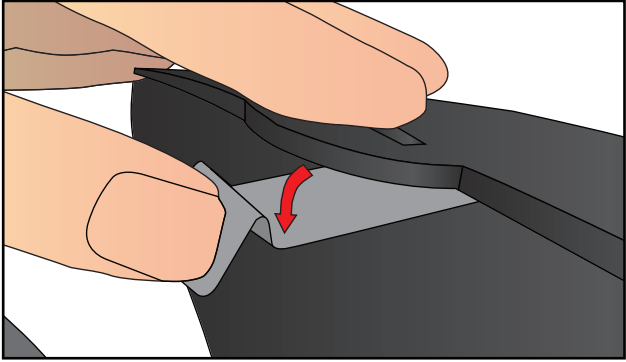

7

7.04

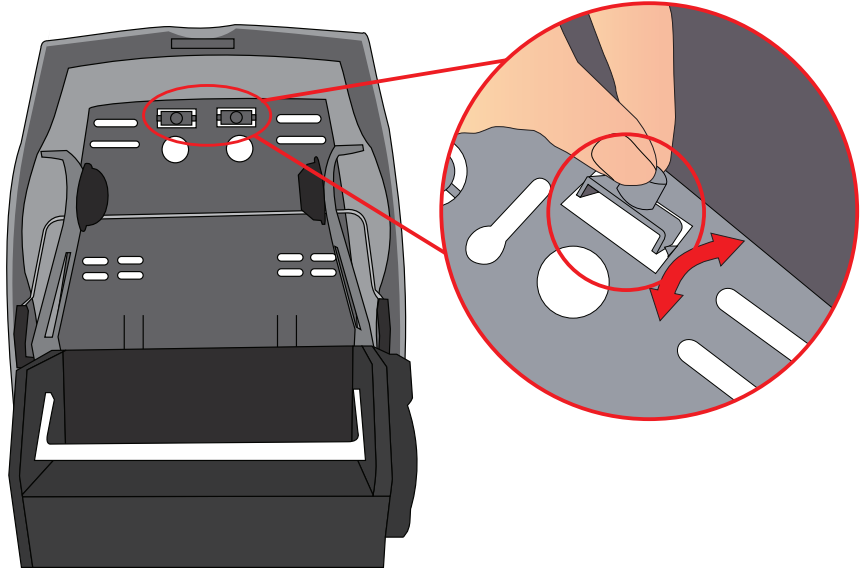

7

7.05

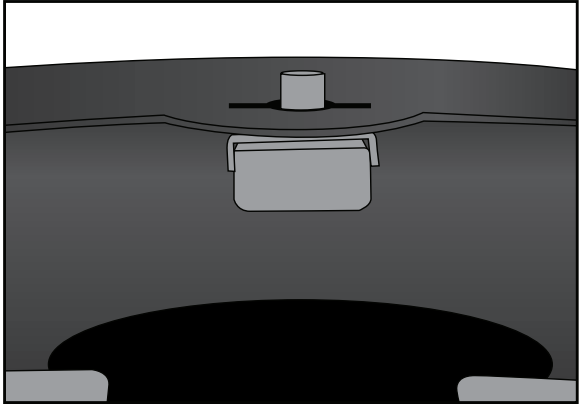
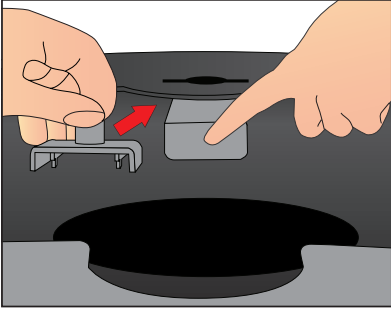

7

7.06

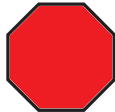

7



[www.dispensersupport.com](http://www.dispensersupport.com)

®/\* Trademarks of Kimberly-Clark Worldwide, Inc. Marques déposés de Kimberly-Clark Worldwide, Inc.  
©2008 KCWW

Form 033923-W • Rev. 7/2012